

1002651 Interferometer 1002652 Accessory Set for the Interferometer

Instruction sheet

11/15 MH

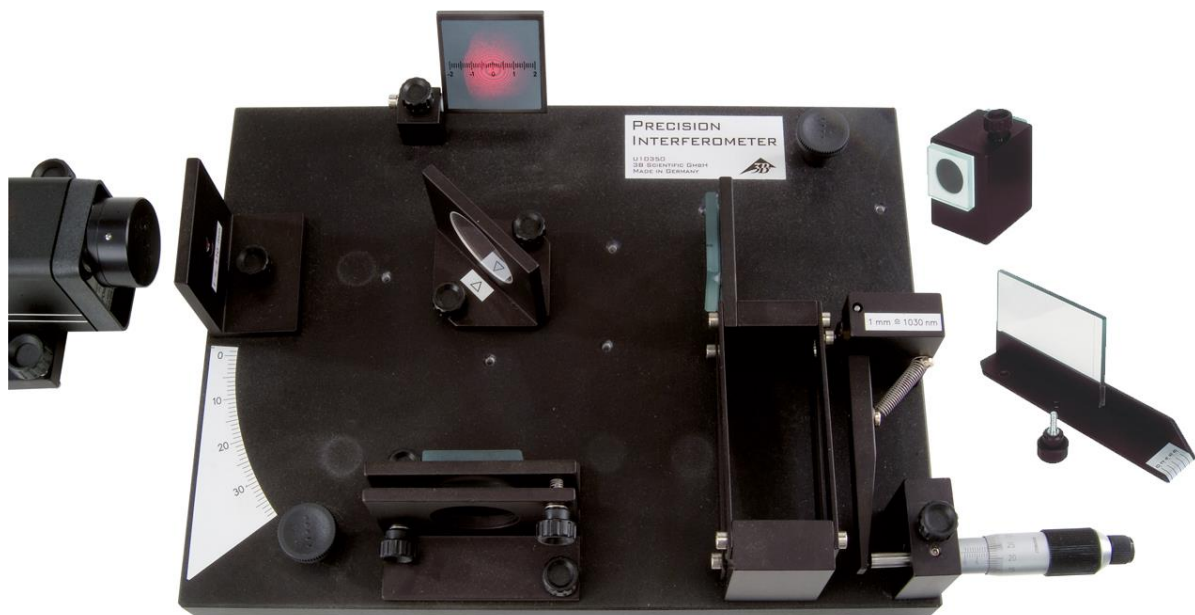

1. Safety instructions

- The interferometer should be operated with a class 2 type He-Ne laser. Any viewing directly into the beam of the laser can lead to retinal burns and must be categorically avoided. The safety instructions accompanying the laser must be strictly adhered to!
- The interferometer is to be set up on a stable bench or some other suitable location so that it cannot fall down and injure someone by virtue of its weight.
- The lifting knobs (14) are used to tilt the interferometer to get a secure hold underneath the base plates.
- The maximum permissible pressure in the vacuum cell (6) amounts to 200 kPa (2 bar) corresponding to 100 kPa (1 bar) over atmospheric. In the case of damage to the cell glass, scratches or cracks for example, then use of the vacuum cell should cease immediately and it should be sent for repair. In experiments using pressure over atmospheric, make sure that no one is located in the cell's explosion radius. If necessary wear protective goggles.

2. Scope of delivery, component designations

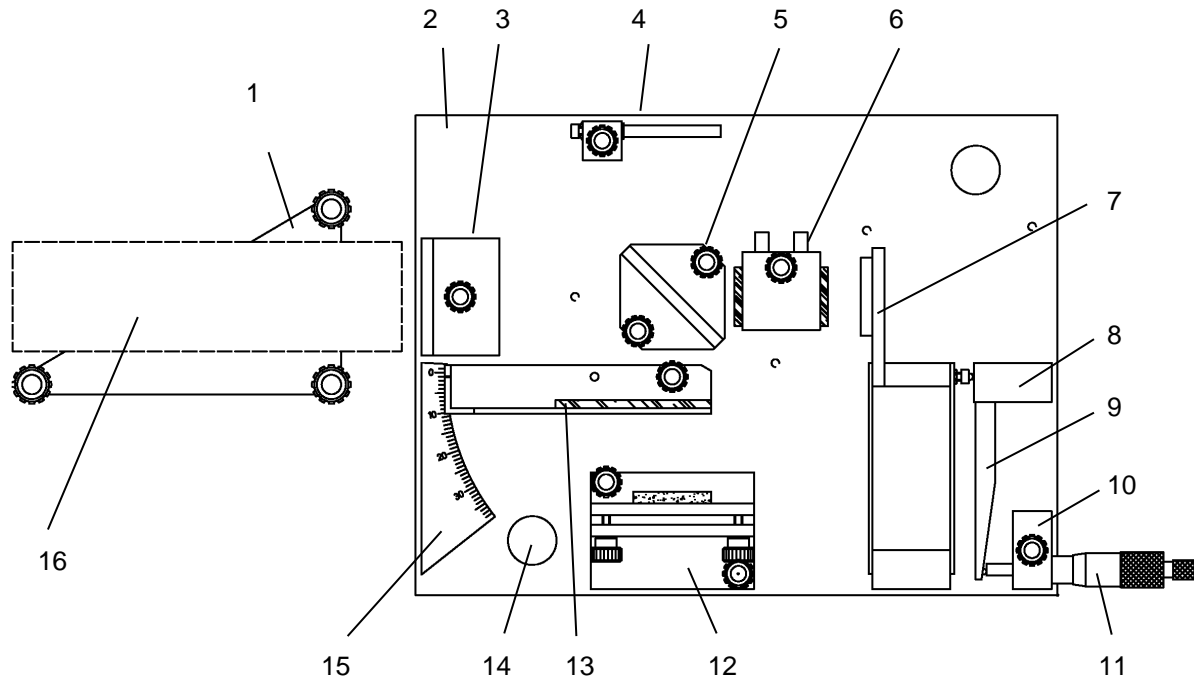

Fig. 1 Scope of delivery

- | | |
|--------------------------------------|---|
| 1 Laser holder | 10 Micrometer holder |
| 2 Base plate | 11 Micrometer |
| 3 Diverging lens | 12 Adjustable mirror |
| 4 (Observation) screen | 13 Glass plate on holder (in supplementary kit) |
| 5 Beam splitter | 14 Lifting knob |
| 6 Vacuum cell (in supplementary kit) | 15 Angle scale |
| 7 Finely adjustable mirror | 16 Laser (not contained in scope of delivery) |
| 8 Eccentric with calibration plate | Robust plastic container (not depicted) |
| 9 Eccentric arm | |

3. Description

In 1881 A. Michelson conducted an experiment in which a light beam was divided into two rays using a beam splitter (cf. Fig. 2). The two beams were reflected back by mirrors and superimposed again inside the beam splitter. Differing path lengths give rise to interference (canceling or reinforcement) between the two beams. If the velocity of light were to differ between the two segments of the beam, this would also lead to interference. That fact made it possible using this experimental arrangement to prove that there was no such thing as an "ether" (a medium for light propagation as hypothesized at the time of the original experiment), since motion through the ether would cause an "ether wind" making a light beam traveling in the direction of the "wind" travel

more quickly than one traveling at right angles to it. Apart from verifying the non-existence of an ether, the interferometer can be used for the measurement of wavelengths or, if the wavelength is known, for measuring very short distances. Among other things, this is very important in testing the surface quality of optical components. These classical experiments and several others can also be performed using the precision interferometer. In detail these include:

1. Michelson Interferometer
2. Fabry-Perot's Interferometer
3. Determination of the refractive index of glass*
4. Determination of the refractive index of air **
5. Twyman-Green test for optical components (qualitative test, non quantitative)*

* with supplementary kit (vacuum cell and glass plate mounted on revolving holder)

** with supplementary kit and vacuum pump

Thanks to the predefined component positions, the equipment can be rapidly reconfigured to conduct different experiments.

4. Technical data

- 5.5 kg heavy, large, rigid base plate (245 x 330 x 25 mm³) for precise and reproducible measurements.
- Large optical components for clear and sharply defined interference patterns: (40 mm Ø and 40 x 40 mm).
- Surface-coated mirror: transmission coefficient 15%, reflection 85% for perpendicular ray incidence.
- Extremely planar beam splitter: front side $1/10 \lambda$, rear side $1/4 \lambda$. Transmission 50%, reflection 50% at 45° angle of incidence, rear side anti-glare coating.
- User-friendly mirror adjustment using an eccentric scale reduction of approx. 1:1000 (a scale mark on the micrometer corresponds to a mirror displacement of approx. 10 nm) for a manufacturing accuracy of $\pm 30\%$. The ratio of micrometer adjustment to mirror adjustment as measured upon manufacture is specified on the calibration plate, e.g. $\hat{=} 830 \text{ nm}$. Using this specification the wavelength measurement should be accurate to at least $\pm 5\%$ (notwithstanding linear aberration and other flaws).
- Due to the adjustable inclination of the reflecting observation screen it is also possible to conduct these experiments in normal daylight conditions (but not in direct sunlight).

5. Operating instructions and maintenance

- Laser assembly: At first the laser has to be mounted on the laser holder. As the laser holder has been designed to accommodate various types of lasers, it has three drill holes for flat-head screws (M5 or M6) although normally only one is needed. The corresponding drill hole for the respective laser is determined by the laser's center of gravity and its fastening options. After assembly, the laser's center of gravity should be located approximately above the center drill hole. The required height of the light beam should be around 60 - 62 mm above the working surface. If the adjustment range of the knurled screws should prove insufficient, mount the laser on top of a suitable spacing washer or similar. The length

of the fastening screw has been selected so that the laser housing, i.e. internal laser components cannot be damaged. Accordingly, it is expedient to first determine the screw's maximum possible penetration depth into the laser housing and then select a screw where the thread sticks out of the laser holder by approx. 2 mm less (included are a bolt and a square nut which fits into conventional grooves).

- Beam splitter: The glass of the beam splitter is antiglare coated on one side and provided with a coating allowing 50% transmission on the other side. The transmitting side is distinguished by a triangle that is also shown on the sketched experiment setups.
- Transport, storage: The eccentric arm (9) should lie on the base of the finely adjustable mirror (7) as on delivery so as to avoid any pressure points developing on the precision-turned eccentric mechanism.
- Eccentric cleaning and maintenance: The turned brass eccentric presses against a polished steel sphere in the holder for the finely adjustable mirror. Dust or other impurities can make the normally smooth mirror adjustment uneven or "jerky". In this case unscrew the eccentric base (8) (the screw heads are located on the underside of the base plate (2)) and clean the brass eccentric as well as the steel sphere. Use a soft rag soaked in petroleum ether, acetone or something similar. When mounting the eccentric make sure that there is a slight pressure being exerted on the steel sphere. After assembly is completed apply a drop of resin-free oil (sewing machine or gun oil) to the contact point between the eccentric and the steel sphere.
- Cleaning optical components made of glass: The surface mirrors, the beam splitter, the diverging lens and the windows of the vacuum cell can be cleaned by carefully wiping them using a soft rag dipped in ethanol (white spirit). Do not press too hard while wiping! It is better to do the work using a lot of ethanol and very little force. The glass plate on the holder (13) should only be wiped clean with a dry rag (if necessary just breathe on it), as otherwise the adhesive foil strip (Twyman-Green experiment) can come off.

6. Experiments

6.1 Michelson Interferometer

6.1.1 Experiment setup

Following equipment is required:

1 Interferometer	1002651
1 He-Ne-Laser	1003165

The setup of the components on the base plate is shown in Fig. 2. It is assumed in the following description of the setup that all the basic settings have to be made in advance.

- Screw the He-Ne laser into its holder (see instructions for assembling laser) and place it so that it is more or less straight in front of the diverging lens.
- Remove the adjustable mirror and beam splitter and fasten the diverging lens straight on the base plate.
- Set the laser so that beam reflected back from the finely adjustable mirror strikes the diverging lens right in the center.
- Loosen the knurled screw of the diverging lens and pivot the lens out of the laser beam by approx. 90° .
- Mount the adjustable mirror and adjust it with the setting screws so that the distance between the plate holding the mirror and the plate holding the screws is just about even all round (5 - 6 mm).
- First loosely fit the beam splitter without tightening the screws so that its partially reflecting side is in the direction of the angle scale, adjusting it within narrow limits so that the two brightest points visible on the observation screen are located on or almost on a vertical line. Once this is achieved the screws of the beam splitter are tightened down.
- Move the adjustable mirror with its adjusting screws until the two brightest points on the screen overlap each other precisely. This should already lead to interference, which is noticeable because of the flickering.
- Turn the diverging lens back into the beam and secure it in position so that the image is close to the middle of the screen (i.e. the bright part of the pattern should be centered not the interference rings). Tilt the screen away from the vertical enough so that the observer sees the brightest and clearest image.
- Now readjust the mirror again so that the

interference rings are in the center of the screen.

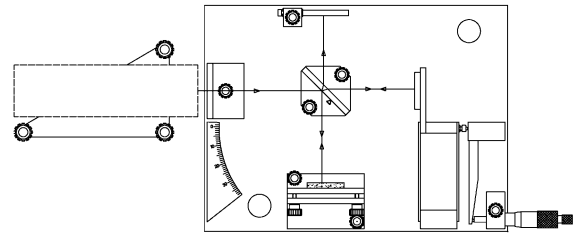

Fig. 2 Experiment setup for the Michelson Interferometer

- In the setup the light propagation times are practically equal, leading to large, clearly discernible distances between the interference rings. However this also causes elliptical distortion of the rings (even identical propagation times for the beams at the mid point result in hyperbolic interference patterns on the screen). In order to obtain near circular rings the beam splitter can be rotated by 180° .

6.1.2 Performing measurements

- Unscrew the micrometer screw counter clockwise out to approx. 25 mm and then slowly screw it back in clockwise to 20 mm. This avoids measurement inaccuracies which may arise when the direction of rotation is reversed.
- Slowly turn the micrometer screw further in clockwise and at the same time count the number n of rings produced. To judge whether a complete ring has been produced, you can use the scale printed on the observation screen. During the measurements keep your breath away from the light beams as much as possible because changes to air density are immediately discernible as “moving” interference rings.
- After at least 20 rings have been counted (the more rings, the more accurate the measurement), read off the micrometer value and note down the result l_M .
- To be able to discern any errors in counting the rings, steps 1-3 should be repeated at least 3 times.

6.1.3 Experiment evaluation

If, for example, during initial measurement $m = 30$ rings were counted and $20 \text{ mm} - l_M = 11,76 \text{ mm}$ is the measured distance then, for gearing of 1:830, the path distance to the mirror is found to be $l_S = 9761 \text{ nm}$ and therefore the wavelength is:

$$\lambda = \frac{2 \cdot l_S}{m} = 651 \text{ nm}$$

Assuming the experiments are performed with care the results of all the measurements should deviate from the mean value by no more than 2. If greater deviations are discovered then the eccentric may need cleaning (see Section 3, eccentric cleaning and maintenance).

The measurement result for the wavelength should be accurate to at least $\pm 5\text{lt}$ it is also possible to perform a check using a laser with a known wavelength (He-Ne-Laser: $\lambda = 632.8\text{ nm}$).

6.2 Refractive index of glass

6.2.1 Experiment setup

Following equipment is required:

1 Interferometer	1002651
1 He-Ne-Laser	1003165
1 Accessory Set for the Interferometer	1002652

The experiment setup initially corresponds to the standard experiment setup (see section 6.1.1). Subsequently the glass plate with the revolving holder is mounted in the portion of beam at the front as shown in Fig. 3. The adjustable mirror is then minimally readjusted until the interference rings are positioned in the middle of the screen.

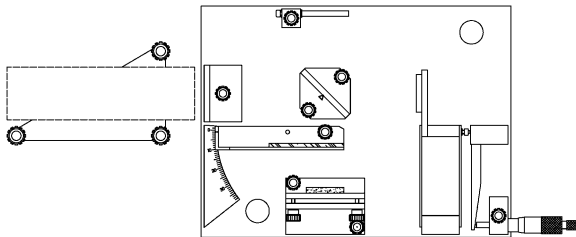

Fig. 3 Experiment setup for measuring the refractive index of glass.

- If the glass plate is now rotated slightly back and forth around the region of 0° , the transition between when interference rings appear and disappear should be precisely at 0° . If this is not the case, then the beam splitter is not positioned precisely at a 45° angle with respect to the finely adjustable mirror. However, since a completely precise alignment of the beam splitter is practically impossible, note down the angle ϕ_0 at which the transition between when interference rings appear and disappear does take place. During the evaluation this angle is subtracted from the measured value ϕ_M to obtain the actual rotation angle ϕ .

6.2.2 Measurement procedure

- The glass plate is slowly rotated starting from the angle ϕ_0 . In the course of this action the number of rings is counted as they disappear. The larger the angle rotated the smaller the change in angle that causes a ring to disappear. Consequently you need to have a very steady hand to count more than approx. 20 rings.

6.2.3 Experiment evaluation

- Taking the angle ϕ (z. B. 5.4°), the measured number of rings m (e.g. 20), the wavelength λ (in air) of the laser being used (e.g. 633 nm) and the thickness of the glass disk t (here 4 mm) we obtain from the refractive index n_G of glass:

$$n_G = \frac{(2t - m\lambda)(1 - \cos \Phi) + \left(\frac{m^2 \lambda^2}{4t}\right)}{2t(1 - \cos \Phi) - m\lambda} = 1.55$$

- When comparing your own results with those found in the literature always bear in mind that the refractive index is a function of the wavelength and consequently only values for the same wavelengths are comparable.

6.3 Refractive index of air

6.3.1 Experiment setup

Following equipment is required:

1 Interferometer	1002651
1 He-Ne-Laser	1003165
1 Accessory Set for the Interferometer	1002652
1 Vakuum Hand Pump	1012856
1 Silikone Tubing	1002622

The experiment setup corresponds initially to the standard experiment setup (see section 6.1.1) with the only change that here it is expedient to have the partially reflecting surface of the beam splitter pointing to the right and rearwards. The vacuum cell is now placed in the right-hand beam as in Fig. 4 and the adjustable mirror is minimally adjusted again to bring the interference rings into the center of the screen.

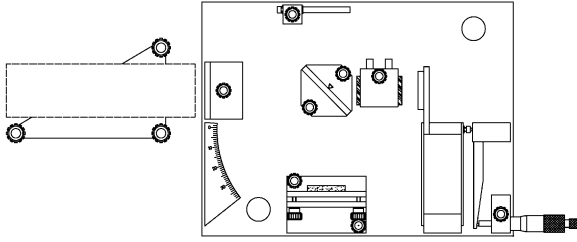

Fig. 4 Experiment setup for measuring refractive index of air.

6.3.2 Measurement procedure

- Connect the vacuum pump to the vacuum cell and note down the displayed pressure p . Then slowly evacuate the cell and count the number of rings m as they disappear. The number of rings that have disappeared for a certain pressure is recorded at regular pressure intervals. When the minimum pressure has been reached (about 10 kPa for a simple hand pump), the vacuum cell is filled with air again. A set of measurements can now be made for pressure over atmospheric (up to max. 200 kPa corresponding to 1 bar over atmospheric).

6.3.3 Experiment evaluation

- At pressure $p = 0$ the refractive index $n = 1$. For increasing pressure, the refractive index increases according to the following equation:

$$n(p) = 1 + \frac{\Delta n}{\Delta p} p$$

- Therefore, to determine the refractive index at normal air pressure, the gradient $\Delta n / \Delta p$ must be derived first. To a first approximation:

$$\frac{\Delta n}{\Delta p} = \frac{\lambda}{2l_z} \left| \frac{\Delta m}{\Delta p} \right|$$

In this case m is the number of rings appearing or disappearing, λ is the wavelength of the light and l_z is the internal length of the vacuum cell (here 41 mm). If, for example, for a pressure $\Delta p = 90$ kPas, a corresponding value of $\Delta m = 25$ is determined, then:

$$\frac{\Delta n}{\Delta p} = 2.14 \times 10^{-9} \frac{1}{\text{Pas}}$$

- This means that the refractive index of air at atmospheric pressure (100 kPas) is $n = 1.00021$. This compares to a value of $n = 1.00029$ as quoted in the literature.

6.4 Twyman-Green Interferometer

This experiment determines the surface quality of optical components. Normally a Twyman-Green interferometer is considered to be one where one (laser) beam is diverging and the other parallel. In order to understand the principle, however, it is possible to use a diverging but not a parallel beam (as in the previous experiments).

6.4.1 Experiment setup

Following equipment is required:

1 Interferometer	1002651
1 He-Ne-Laser	1003165
1 Accessory Set for the interferometer	1002652
1 Sticky tape	

- As an example of a poor optical surface, transparent sticky tape is used. The tape is glued to a glass plate and appears homogeneously transparent when peered through in the normal way.
- The experiment setup is initially the same as that of the standard experiment (see section 6.1.1). Thereafter the glass plate with rotating holder introduced into the beam at front as in Fig. 5. The adjustable mirror is then minimally readjusted so that the interference rings appear in the middle of the screen.

6.4.2 Measurement procedure

- On the right-hand side of the observation screen, regular interference rings can be seen as in Experiment 6.1. On the left-hand side, however, the rings are fuzzy and bright points appear in what are really dark regions and vice versa. Since we know from Experiment 6.2 that even tiny changes in the thickness of coatings (accomplished in Experiment 6.2 by rotating the glass plate) can cause the interference rings to shift, the implication is that the distortion in the rings can be explained by the bumpy, uneven surface of the sticky tape.

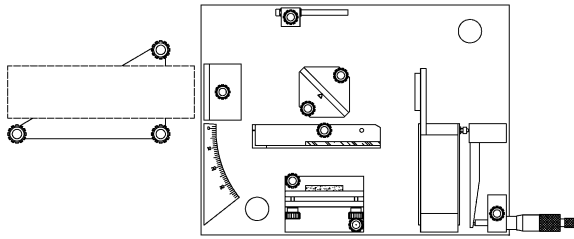

Fig. 5 Experiment setup for measuring the surface quality of optical components.

6.5 Fabry-Perot Interferometer

6.5.1 Experiment setup

Following equipment is required:

1 Interferometer	1002651
1 He-Ne-Laser	1003165

The setup of the components on the base plate is shown in Fig. 6. It is assumed in the following description of the setup, that all the basic settings have to be made in advance.

- Screw the He-Ne laser into its holder (see above instruction for assembling laser) and position it so that it is more or less straight in front of the diverging lens.
- Remove the adjustable mirror and the diverging lens and place the laser in front of the base plate so that it is slightly turned about a vertical axis. Then adjust the inclination of the laser so that part of the beam that is reflected back onto the laser is at the same height as the emitted beam. If the laser is now turned straight in front of the base plate again, two points appear on the screen. Adjustments should then be made to cause the two points to coincide.
- Place the diverging lens in the beam and, if necessary, adjust the height of the beam by turning all three knurled screws by the same amount. Then return to the second one as required. (It may be that weak interference rings are apparent on the screen since even the ostensibly transparent side of the glass of the finely adjustable mirror also reflects the beam slightly.)
- Turn the diverging by 90° again so that it is out of the beam.
- Mount the adjustable mirror with great care. The distance between the two mirrors should be about 2 mm.

- Set up the adjustable mirror so that all the points and any interference patterns coincide on the screen.
- Turn the diverging lens back into the beam and secure it in position so that the image is in the middle of the screen (i.e. the bright part of the beam should be centered not the interference rings). Tilt the screen away from the vertical enough so that the observer sees the brightest and clearest image.
- Make more slight adjustments to the adjustable mirror to bring the interference rings to the center of the screen.

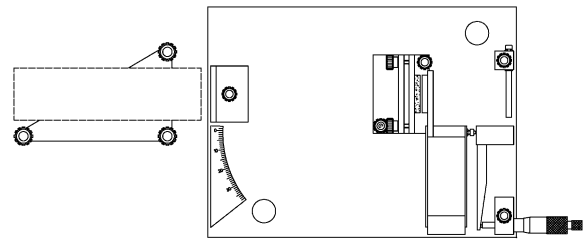

Fig. 6 Experiment setup for Fabry-Perot interferometer.

6.5.2 Measurement procedure

- Unscrew the micrometer screw counter clockwise out to approx. 25 mm and then slowly screw it back in clockwise to 20 mm. This avoids measurement inaccuracies which may arise when the direction of rotation is reversed. Unscrew the micrometer screw counter clockwise out to approx. 25 mm and then slowly screw it back in clockwise to 20 mm. This avoids measurement inaccuracies which may arise when the direction of rotation is reversed.
- Slowly turn the micrometer screw further in clockwise and at the same time count the number m of rings produced.
- After at least 20 rings have been counted, read off the micrometer value and note down the result l_M .
- To avoid any errors in counting the rings, steps 1-3 should be repeated at least three times.

6.5.3 Experiment evaluation

- If, for example, the number of rings counted is $m = 40$ and 20 mm – $l_M = 15,13$ mm is measured distance, the beam path to the mirror (eccentric = 1:830) is $l_S = 12560$ nm so that the wavelength is (see explanation in section 6.1.3):

$$\lambda = \frac{2l_S}{m} = 628 \text{ nm}$$